

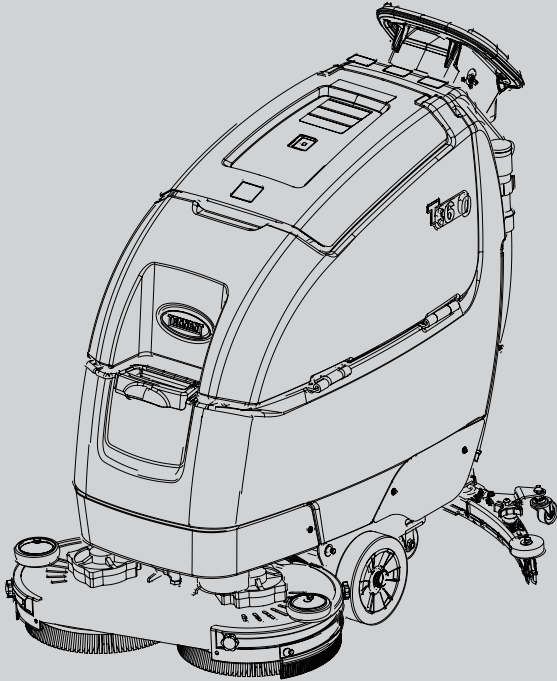

T360

Walk-Behind Scrubber English **EN** Operator Manual



North America / International



For the latest Parts Manuals and other language Operator Manuals, visit:

www.tennantco.com/manuals

TN7100065
Rev. 00 (6-2025)



INTRODUCTION

This manual is furnished with each new model. It provides necessary operation and maintenance instructions.



Read this manual completely and understand the machine before operating or servicing it.

This machine will provide excellent service. However, the best results will be obtained at minimum costs if:

- The machine is operated with reasonable care.
- The machine is maintained regularly - per the machine maintenance instructions provided.
- The machine is maintained with manufacturer supplied or equivalent parts.

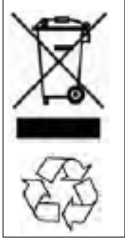

PROTECT THE ENVIRONMENT

Please dispose of packaging materials, used components such as batteries and fluids in an environmentally safe way according to local waste disposal regulations.

Always remember to recycle.

MACHINE DATA

Please fill out at time of installation for future reference.

Model No. - _____

Serial No. - _____

Installation Date - _____



INTENDED USE

The T360 Walk-Behind Floor Scrubber is intended for commercial use such as hotels, schools, hospitals, factories, stores, offices and rental businesses. It can scrub hard surfaces in indoor environments, such as concrete, asphalt, stone and synthetic materials. This machine is not suitable for cleaning carpets or sanding wood flooring. Use only recommended pads/brushes and commercially available floor cleaners. Do not perform any operations other than those described in this Operator's Manual.

Unpacking the machine:

Carefully inspect the machine for signs of damage. Report the damage to the operator immediately. Contact your dealer or Tennant if any item is missing. To unpack the machine, remove the tie-wraps, wheel stoppers, and transport brackets. Carefully tip the machine off the pallet using the ramp provided. Make sure the brush head is in the raised position.

NOTE: The machine must be removed from the pallet using a ramp, otherwise it will be damaged.

North America/International:

Tennant Company
10400 Clean Street, Eden Prairie,
MN 55344-2650
Telephone: (800) 553-8033
www.tennantco.com

EMEA region:

Tennant N.V.
Industrielaan 6 5405 AB
P.O. Box 6 5400 AA, Uden -The Netherlands
Europe@tennantco.com

Specifications and parts are subject to change without notice.

Copyright ©2025 Tennant Company. All rights reserved.

Table of Contents

Important Safety Instructions.....	4
Safety Labels	6
Operation.....	9
Machine Components	9
Controls.....	10
Machine Symbols.....	10
Installing The Batteries.....	11
How The Machine Works	12
Machine Installation	12
Attaching The Squeegee Assembly	12
Installing The Brush / Pad.....	14
Filling The Solution Tank.....	14
Machine Operation.....	15
Pre-Operation Checklist.....	15
Operating The Machine.....	15
Emergency Stop Button	16
During Machine Operation	16
Circuit Breakers	17
Hour Meter	17
Draining The Tanks	18
Draining The Recovery Tank.....	18
Maintenance	19
Maintenance Of The Machine	20
Yellow Contact Points	26
Batteries.....	21
Squeegee Blade Replacement	22
Pushing Or Towing The Machine	24
Transporting The Machine	24
Storage Of The Machine.....	24
Antifreeze Protection.....	24
Troubleshooting	25
Specifications	28
General Machine.....	28
Machine Dimensions.....	28

IMPORTANT SAFETY INSTRUCTIONS

- SAVE THESE INSTRUCTIONS

The following precautions are used throughout this manual as indicated in their descriptions:



WARNING: To warn of hazards or unsafe practices that could result in severe personal injury or death.

FOR SAFETY: To identify actions that must be followed for safe operation of equipment.

The following information signals potentially dangerous conditions to the operator. Know when these conditions can exist. Locate all safety devices on the machine. Report machine damage or faulty operation immediately..



WARNING: Lead-acid batteries emit hydrogen gas. Explosion or fire can result. Keep sparks and open flame away. Keep covers open when charging.



WARNING: Flammable materials can cause an explosion or fire. Do not use flammable materials in tank(s).



WARNING: Flammable materials or reactive metals can cause an explosion or fire. Do not pick up.



WARNING: Magnetic Field Hazard. Magnetic pad driver/brush can be harmful to those with pacemakers or medical implants.



WARNING: Electrical Hazard

– Disconnect Battery Cables and Charger Plug Before Servicing Machine.

– Do Not Charge Batteries with Damaged Power Supply Cord. Do Not Modify Plug.

If the charger supply cord is damaged or broken, it must be replaced by the manufacturer or its service agent or a similarly qualified person in order to avoid a hazard.

FOR SAFETY:

1. Do not operate machine:
 - Unless trained and authorized.
 - Unless operator manual is read and understood.
 - Under the influence of alcohol or drugs.
- While using a cell phone or other types of electronic devices.
- Unless mentally and physically capable of following machine instructions.
- If it is not in proper operating condition.
- With pads or accessories not supplied or approved by Tennant. The use of other pads may impair safety.
- In outdoor areas. This machine is for indoor use only.
- In areas where flammable vapors/liquids or combustible dusts are present.
- In areas that are too dark to safely see the controls.
- In areas with possible falling objects unless equipped with overhead guard.
2. Before Starting Machine:
 - Check machine for fluid leaks.
 - Make sure all safety devices are in place and operate properly.
3. When using machine:
 - Use only as described in this manual.
 - Go slowly on inclines and slippery surfaces.
 - Reduce speed when turning.
 - Always be aware of surroundings while operating machine.
 - Do not scrub or sweep on ramp inclines that exceed 2% grade.
 - Keep children and unauthorized persons away from machine.
 - Report machine damage or faulty operation immediately.
 - Follow mixing, handling and disposal instructions on chemical containers.
 - Follow site safety guidelines concerning wet floors.
 - Do not leave machine alone when filling the water tank.
 - Park machine on level surface when filling solution tank with auto-fill feature.
4. Before leaving or servicing machine:
 - Stop on level surface.
 - Turn off machine and remove key.
5. When servicing machine:
 - All work must be done with sufficient lighting and visibility.
 - Keep work area well ventilated.
 - Avoid moving parts. Do not wear loose clothing, jewelry and secure long hair.
 - Block machine tires before jacking machine up.
 - Jack machine up at designated locations only. Support machine with jack stands.
 - Use hoist or jack that will support the weight of the machine.

- Do not power spray or hose off machine near electrical components.
- Disconnect battery connections and charger cord before working on machine.
- Do not pull on battery charger cord to unplug. Grasp plug at outlet and pull.
- Do not use incompatible battery chargers as this may damage battery packs and potentially cause a fire.
- Inspect charger cord regularly for damage.
- Do not disconnect the off-board charger's DC cord from the machine receptacle when the charger is operating. Arcing may result. If the charger must be interrupted during charging, disconnect the AC power supply cord first.
- Avoid contact with battery acid.
- Keep all metal objects off batteries.
- Use a non-conductive battery removal device.
- Use a hoist and adequate assistance when lifting batteries.
- Battery installation must be done by trained personnel.
- Follow site safety guidelines concerning battery removal.
- All repairs must be performed by a trained service mechanic.
- Do not modify the machine from its original design.
- Use Tennant supplied or approved replacement parts.
- Wear personal protective equipment as needed and where recommended in this manual.



For Safety: wear hearing protection.



For Safety: wear protective gloves.



For Safety: wear eye protection.



For Safety: wear protective dust mask.

Safety Labels - Europe Labels

Safety labels appear at the positions indicated on the machine. Replace labels if lost, damaged or become illegible.

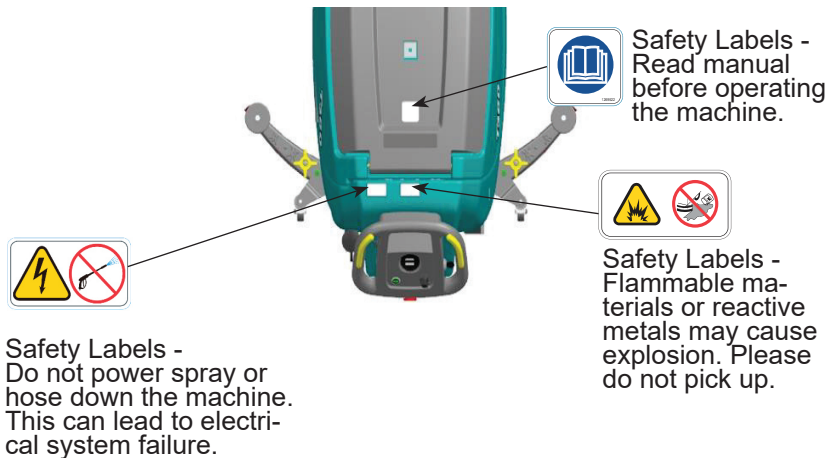

Safety Labels - North American Labels

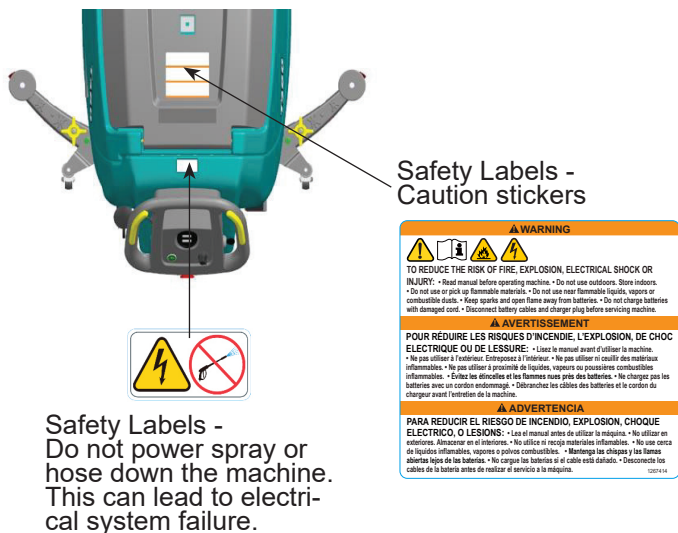

⚠ WARNING

TO REDUCE THE RISK OF FIRE, EXPLOSION, ELECTRICAL SHOCK OR INJURY: • Read manual before operating machine. • Do not use outdoors. Store indoors. • Do not use or pick up flammable materials. • Do not use near flammable liquids, vapors or combustible dusts. • Keep sparks and open flame away from batteries. • Do not charge batteries with damaged cord. • Disconnect battery cables and charge plug before servicing machine.

⚠ AVERTISSEMENT

POUR RÉDUIRE LES RISQUES D'INCENDIE, L'EXPLOSION, DE CHOC ÉLECTRIQUE OU DE LÉSSURE: • Lisez le manuel avant d'utiliser la machine. • Ne pas utiliser à l'extérieur. Stockez à l'intérieur. • Ne pas utiliser si vous êtes près de matériaux inflammables. • Ne pas utiliser à proximité de liquides, vapeurs ou poussières combustibles inflammables. • Éloignez les étincelles et les flammes nues près des batteries. • Ne chargez pas les batteries avec un cordon endommagé. • Débranchez les câbles des batteries et le cordon de chargeur avant l'entretien de la machine.

⚠ ADVERTENCIA

PARA REDUCIR EL RIESGO DE INCENDIO, EXPLOSION, CHOQUE ELÉCTRICO, O LESIONES: • Lea el manual antes de utilizar la máquina. • No utilizar en exteriores. Almacene en el interior. • No utilice ni recoja materiales inflamables. • No use cerca de líquidos inflamables, vapores o polvos combustibles. • Mantenga las chispas y las flamas abiertas lejos de las baterías. • No cargue las baterías si el cable está dañado. • Desconecte los cables de la batería antes de realizar el servicio a la máquina.

1201114

Safety Labels - Europe & North America

Safety labels appear at the positions indicated on the machine. Replace labels if lost, damaged or become illegible



Warning Labels - Flammable materials may cause explosion or fire. Do not use flammable materials in the tank.



Safety Labels - Do not step on.



Warning Labels - Spinning brush. Keep hands off.



Warning Labels - Magnetic field hazard. Magnetic needle holders/brushes can interfere with the proper functioning of pacemakers or other medical implants.

SAFETY LABELS - Europe & North America

Safety labels appear at the positions indicated on the machine. Replace labels if lost, damaged or become illegible.



Warning Labels - Batteries emit hydrogen. This may cause explosion or fire. Keep away from sparks and open flames when charging.

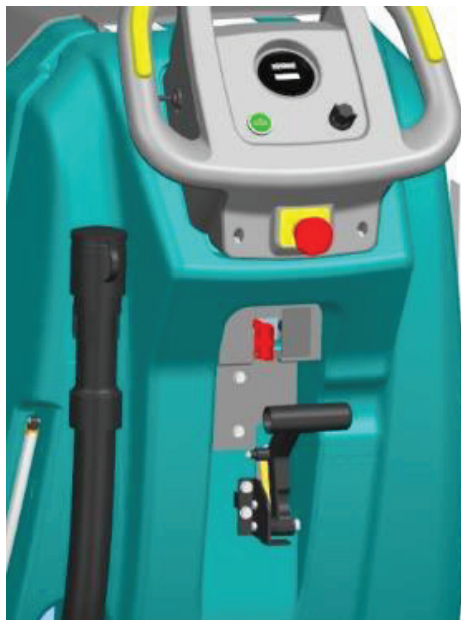

Warning Labels - Electric shock hazard. Disconnect battery cords before servicing the machine.

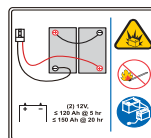
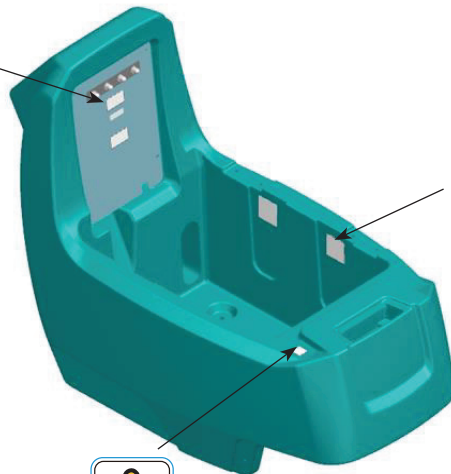

Warning Labels - Batteries emit hydrogen. This may cause explosion or fire. Keep away from sparks and open flames when charging.



Safety Labels - Watch Your Hands

OPERATION

MACHINE COMPONENTS

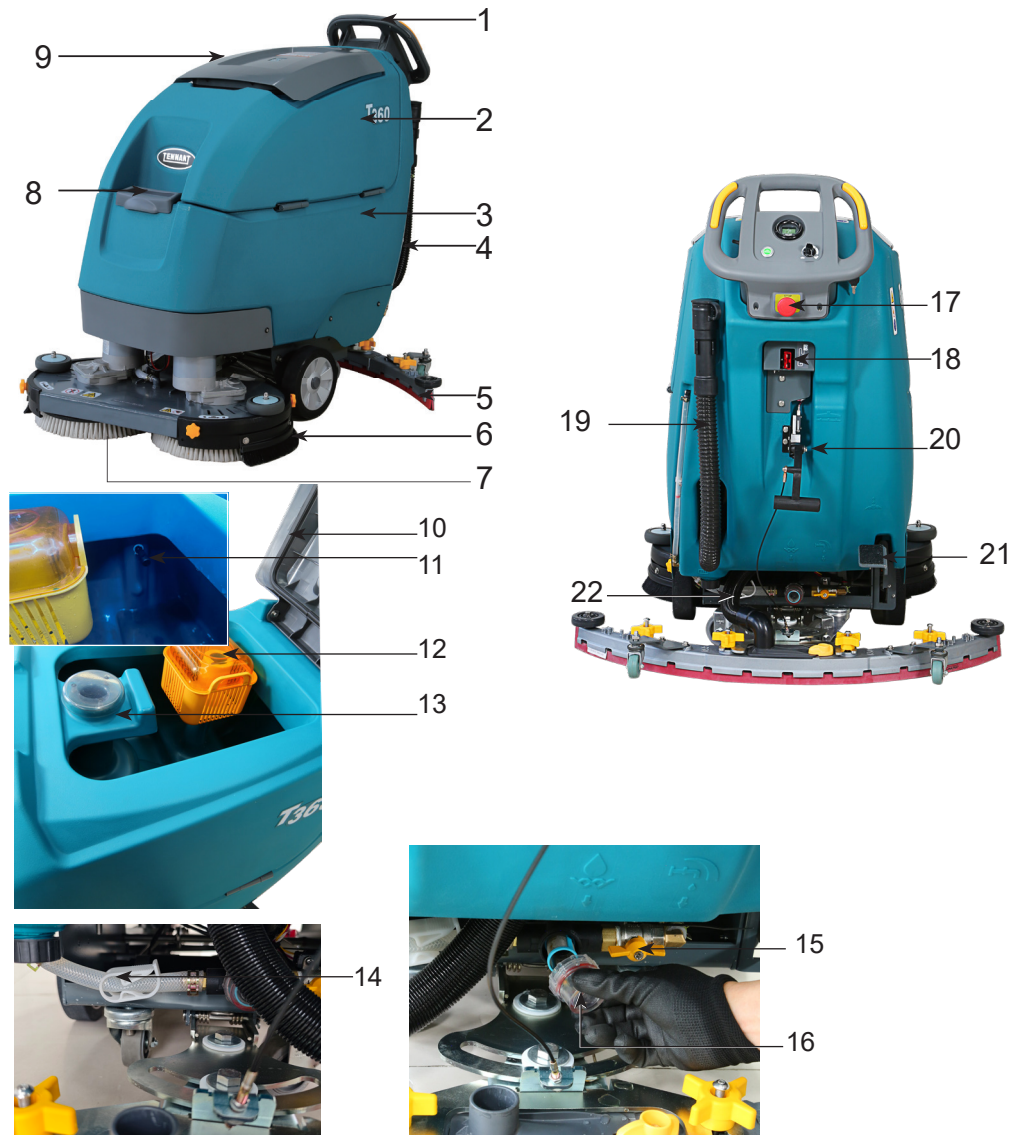

- | | |
|-------------------------------|------------------------------|
| 1. Console | 18. Charging port |
| 2. Solution tank | 19. Recovery tank drain hose |
| 3. Recovery tank | 20. Squeegee lift handle |
| 4. Solution tank level tube | 21. Brush lift foot pedal |
| 5. Squeegee assembly | 22. Squeegee vacuum hose |
| 6. Brush plate skirt | |
| 7. Scrub head | |
| 8. Solution tank fill port | |
| 9. Recovery tank cover | |
| 10. Recovery tank seal | |
| 11. Recovery tank sensor | |
| 12. Recovery tank debris tray | |
| 13. Vacuum fan cover | |
| 14. Solution hose clamp | |
| 15. Solution valve knob | |
| 16. Solution filter screen | |
| 17. Emergency stop button | |

CONTROLS

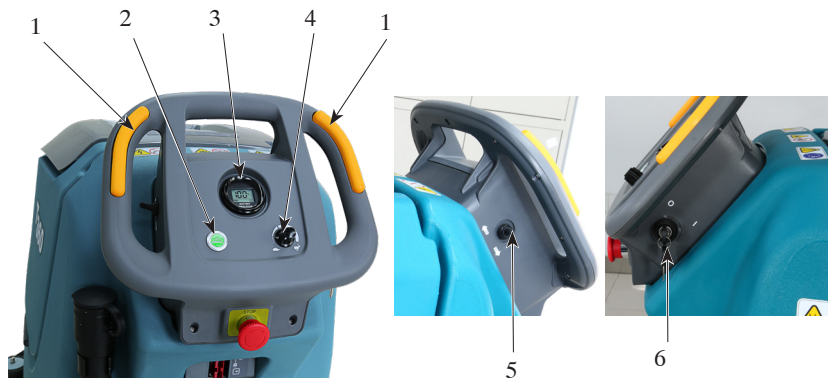

1. Drive button
2. Brush button
3. Power gauge/Hour meter
4. Speed knob
5. Forward/Reverse switch
6. Main power switch

MACHINE SYMBOLS

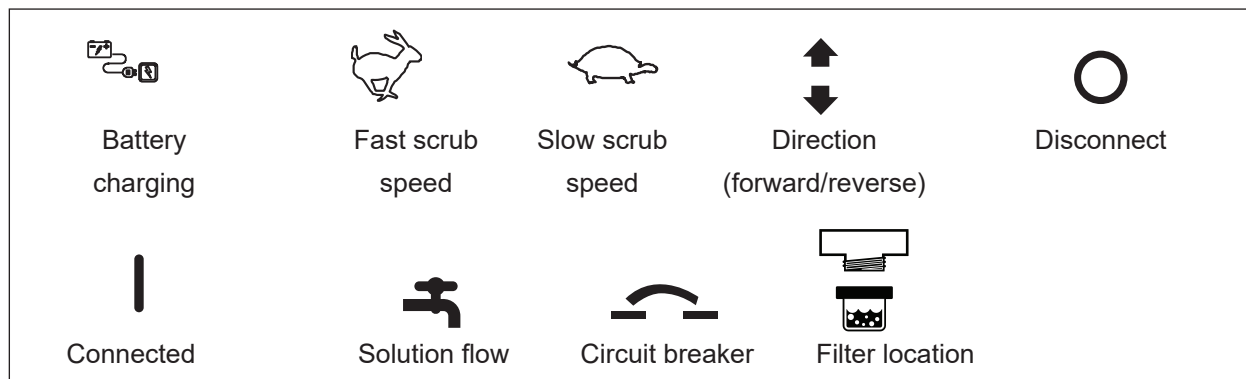

INSTALLING THE BATTERIES

WARNING: Lead-acid batteries emit hydrogen gas. Explosion or fire can result. Keep sparks and open flame away. Keep covers open when charging.

To ensure safety: Wear necessary personal protective equipment when servicing the machine. Avoid contact with battery acid.

Battery specifications

Requires two 12-volt deep-cycle batteries

Battery capacity is 120Ah@3hr

Contact dealer or Tennant for battery recommendations.

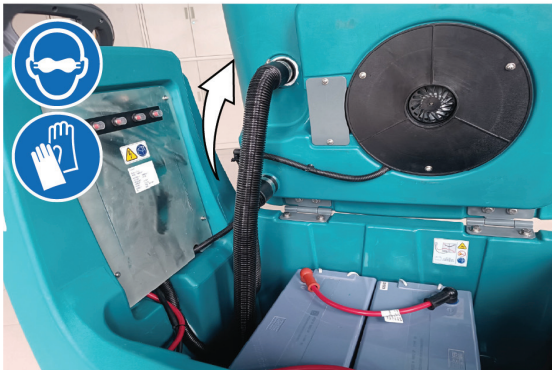

To ensure safety: Before leaving or servicing the machine, park the machine on a level surface, turn off the machine and remove the key.

1. Lift the recovery tank to gain access to battery compartment.
2. Carefully install the batteries into battery compartment tray and arrange battery terminals as shown.

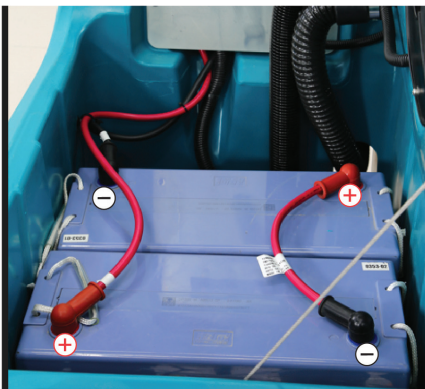

To ensure safety: When servicing batteries, lift them using a hoist or suitable auxiliary equipment.

3. Using the supplied battery terminal protective cover to connect the cords to the battery terminals, with the red one connected to positive (+) and black one connected to negative (-). Tighten cable connections to the batteries per battery manufacturer's specifications.

HOW THE MACHINE WORKS

A mixture of water and cleaning solution is sprayed from the solution tank onto the floor and cleaned by a rotating brush/pad. As the machine moves forward, the squeegee and vacuum fan suck the dirty water from the floor into the recovery tank..

Brushes and Pads Information

For best results, use the correct brush or pad for cleaning applications. Below is a list of brushes and pads and the best application scenario.

Note: The amount and type of soil is important in deciding what type of brush or pad to use. For specific advice, please contact Tennant service representatives.

Soft nylon scrub brush (white) -



Pad driver -



MACHINE INSTALLATION

ATTACHING THE SQUEEGEE ASSEMBLY

FOR SAFETY: Before leaving or servicing machine, stop on level surface, turn off machine, and remove key.

1. Raise the squeegee bracket.



2. Install the squeegee assembly onto the squeegee mounting bracket. Tighten the handle to secure the squeegee assembly to the shelf.



3. Connect the vacuum hose to the squeegee assembly.



4. Check the squeegee blade for proper deflection. The blade should deflect as shown in the figure.



5. To adjust the blade deflection, loosen the locknut and turn the caster hex plate until there is a $(1/16'' / 2\text{mm})$ gap between the caster and the floor.

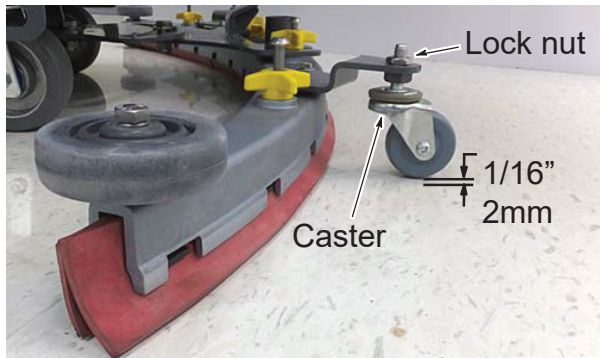

6. Retighten the locknut and repeat the steps for the other caster.

INSTALLING THE BRUSH / PAD

1. Raise scrub head off the floor and remove the key.

FOR SAFETY: Before leaving or servicing machine, stop on level surface, turn off machine, and remove key.

2. Attach the pad on pad driver. Secure pad with center-lock.



To ensure safety: Do not operate machine with pads or replacement parts not supplied or approved by Tennant. Use of other pads may compromise safety.

3. Place the brush under the scrub head and lift the brush up until it engages magnet securely.



WARNING: Magnetic Field Hazard.
Magnetic pad driver/brush can be harmful to those with pacemakers or medical implants.

Replace the pads of brushes when they no longer clean effectively.

4. To remove the pad driver/brush, push downward on pad driver/brush.

FILLING THE SOLUTION TANK

FOR SAFETY: Before leaving or servicing machine, stop on level surface, turn off machine, and remove key.

1. Remove the cover from the solution tank.



2. Insert the fill hose into the black filter mesh and make sure that the hose is securely fastened in the filter.



3. Fill the solution tank with water until the level reaches the 1 mark on the water tank indicator.



Fill the solution tank with water (not exceeding 60°C / 140°F). Pour the recommended cleaner into the water tank and mix according to the mixing ratio instructions on the container.

Note: Always use a recommended commercial cleaner. The manufacturer will not be responsible for the warranty if the damage is caused by improper use of cleaner.



WARNING: Flammable materials can cause an explosion or fire. Do not use flammable materials in tank(s).

4. Turn off the water supply and remove the fill hose from the black filter mesh.
5. Close the solution tank fill port cover.

MACHINE OPERATION

FOR SAFETY: DO NOT operate the machine unless operator manual is read and understood.

PRE-OPERATION CHECKLIST

- Check brushes for wear and damage. Remove any wire, string, or twin strands tangled around the main brush.
- Check the scrub head skirt for wear and damage to ensure that the skirt is properly secured to the scrub head.
- Clean the squeegee drip trap reservoir.
- Check the squeegee vacuum hose for debris or obstructions.
- Check the squeegee for damage and wear.
- Confirm recovery tank is drained and clean.
- Check the seal of the recovery tank cover for damage and wear.
- Clean the recovery tank debris tray.
- Clean the solution tank filter screen.
- Check machine for proper operation.

OPERATING THE MACHINE

1. Start the power by turning on the main power switch.

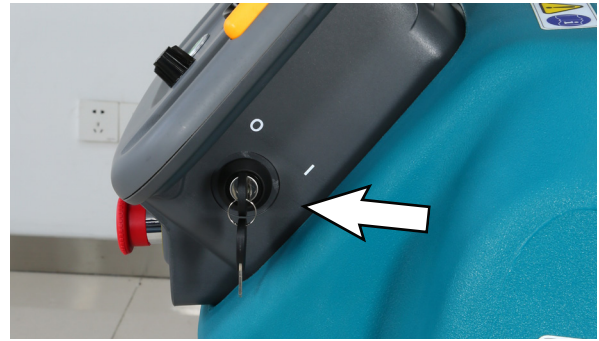

2. Press the brush plate lift pedal to the left (as shown by the arrow).

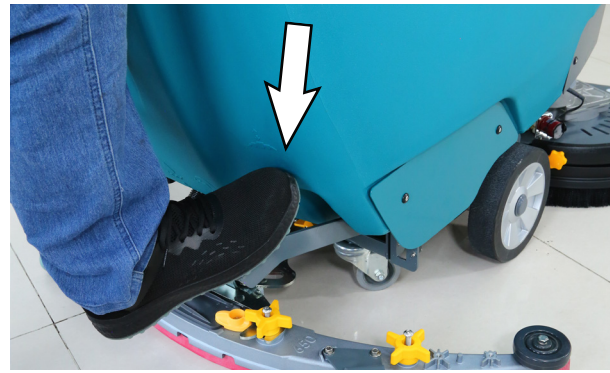

3. Adjust the forward/reverse switch to the desired direction. Press the brush button and adjust the speed.



4. Lower the squeegee lift handle so that the squeegee assembly is on the floor.



OPERATION

5. Manually adjust the solution valve to desired amount of water output.

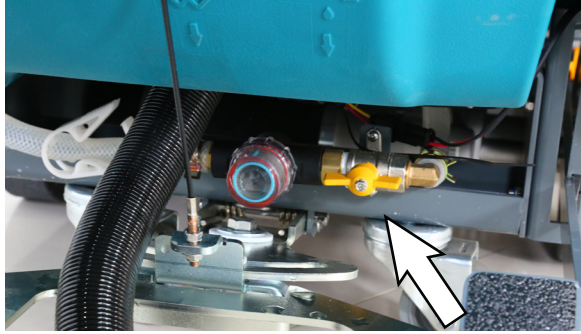

6. Hold both sides on the console and press the yellow handle buttons lightly with thumbs to start scrubbing.



7. To stop scrubbing, turn the brush button off, raise the brush off floor and continue forward a certain distance to pick up remaining water on floor then raise the squeegee lift handle. Turn off the main power switch.

EMERGENCY STOP BUTTON

In the event of an emergency, press the emergency stop button. The red button turns off all power to the machine. To reapply power, turn the button clockwise and restart the key.



DURING MACHINE OPERATION



WARNING: Flammable materials or reactive metals can cause an explosion or fire. Do not pick up.

1. Each scrubbing track overlaps by 2 in/5 cm.
2. Keep the machine moving to prevent damage to the finish of the floor.
3. If water streaks appear on floor, wipe the squeegee blade with a cloth.
4. Avoid bumping the machine into pillars and walls.

FOR SAFETY: When operating the machine, the machine can only be operated where the gradient does not exceed 2%.

5. If there is excessive foam, pour the recommended foam control solution into the recovery tank.

Note: The excessive foam may cause damage to the vacuum motor.

6. For heavily soiled areas, use double scrubbing method. When cleaning the area for the first time, raise the squeegee, allow the solution to soak for 3-5 minutes, then lower the squeegee and clean the area again .

CIRCUIT BREAKERS

The machine is equipped with resettable overload reset switches to avoid damage to brush plates, motors, etc. See figure (as in the diagram below) for the overload reset switches.

When the overload reset switch triggers a circuit break, determine the cause of the circuit break and allow the motor to cool before manually pressing the overload reset switch button.



Circuit break	Rating	Circuit protection
CB1	5 amps	Main
CB2	25 amps	Vacuum motor
CB3	25 amps	Brush motor
CB4	25 amps	Brush motor

For service of the machine, please contact an authorized service center.

To ensure safety: When maintaining the machine, all repair work must be performed by trained personnel.

HOUR METER

The battery discharge indicator includes an hour meter. Records total number of hours the brush motor is on. Use the hour meter to determine when recommended maintenance procedures should be performed and record the service history.



DRAINING THE TANKS

DRAINING THE RECOVERY TANK

Drain the recovery tank after each use.

1. Transport the machine to the drain area.

FOR SAFETY: Before leaving or servicing machine, stop on level surface, turn off machine, and remove key.

2. Remove the recovery tank drain hose from the hook, place the hose nozzle near the drain, remove the cap from the hose, and empty the recovery tank.



NOTE: When using a bucket to collect the dirty water from the recovery tank, do not use the same bucket to fill the water tank with the solution.

3. Remove and empty the debris tray.



4. Rinse the recovery tank with clean water and remove any soil residue.

FOR SAFETY: Do not power spray or hose down the machine while servicing the machine. This can lead to electrical system failure. Use a damp cloth.

DRAINING THE SOLUTION TANK

Drain the solution tank daily.

1. Transport the machine to an area with floor drain.

FOR SAFETY: Before leaving or servicing machine, stop on level surface, turn off machine, and remove key.

2. To drain the solution tank, unscrew the solution tank drain plug.

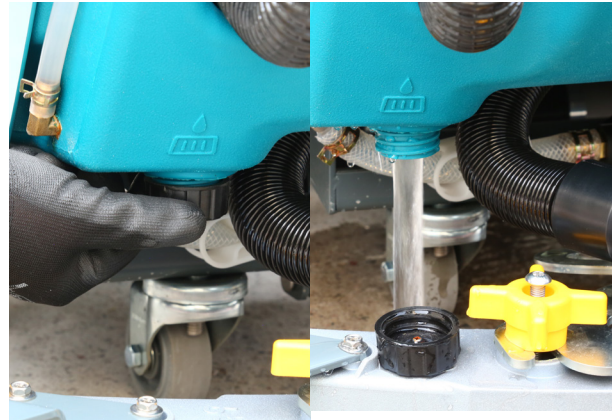

3. Rinse the solution tank with clean water. After flushing/draining the tank, securely solution tank drain cap.

4. Remove and clean the solution tank filter after every 50 hours of use. Be sure to empty the solution tank before removing the filter.



MAINTENANCE

The table below identifies the persons responsible for each procedure.

O = Operator.

T = Trained person.

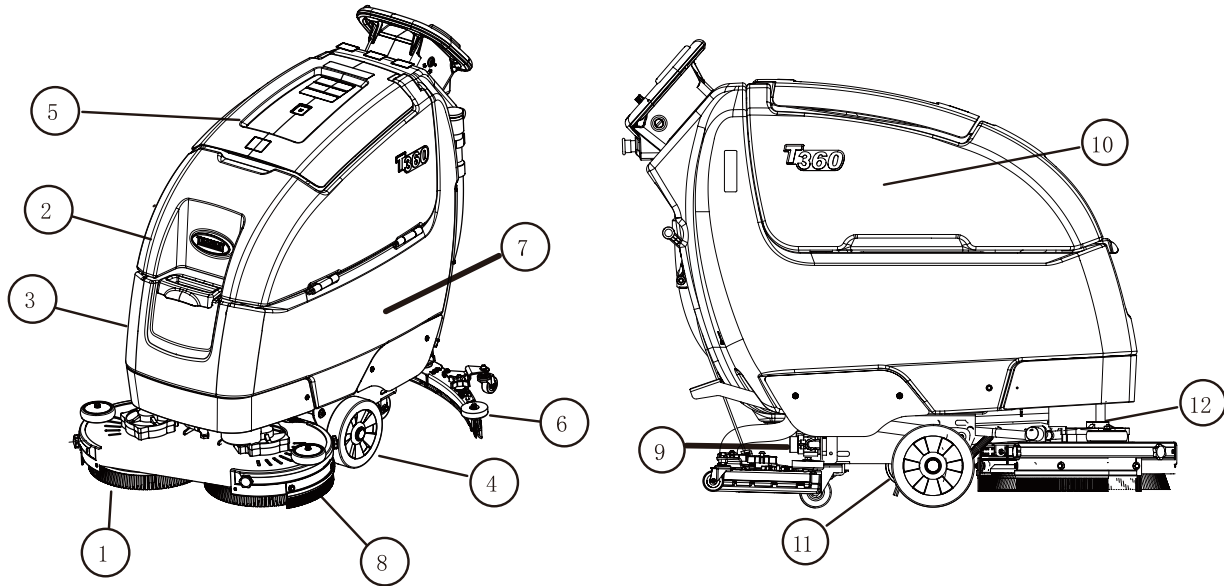

Interval	Person Resp.	Key	Description	Procedure
Daily	O	1	Cleaning pads	Check, rotate or replace
	O	1	Scrub brushes	Check, clean
	O	6	Squeegee	Clean, check for damage and wear
	O	8	Scrub head skirts	Check for damage and wear
	O	2	Recovery tank	Drain, rinse, clean float cage screen and debris tray
	O	3	Solution tank	Drain, rinse
	O	7	Batteries	Charge (if necessary)
50 Hours	O	5	Recovery tank seal	Check for wear
	O	9	Solution tank filter	Remove and clean
200 Hours	O	7	Battery terminals and cables	Check and clean
500 Hours	T	7	Casters	Check for damage and wear
800 Hours	T	11	Propel motor	Replace carbon brushes
1000 Hours	T	10	Vacuum motor	Replace carbon brushes
	T	12	Scrub brush motor	Replace carbon brushes

MAINTENANCE OF THE MACHINE

To keep the machine in good working order, simply follow the maintenance procedures below.

FOR SAFETY: Before leaving or servicing machine, stop on level surface, turn off machine, and remove key.

Wear necessary personal protective equipment when servicing the machine.

YELLOW CONTACT POINTS

This machine has easy-to-find yellow contact points for convenient access to service items. No tools are required for these maintenance operations.

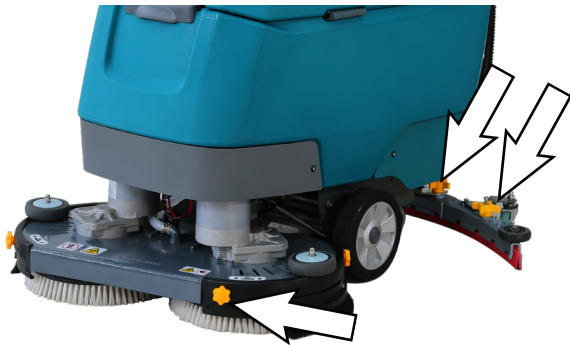

1. Replace pads or turn over if worn. See “Brush and Pad Replacement”.



2. Replace brushes when they do not effectively clean. See “Brush and Pad Replacement”.

3. Wipe the squeegee blade clean. Inspect the blade for wear and damage. If worn, rotate blades. See “Squeegee Blade Replacement.”

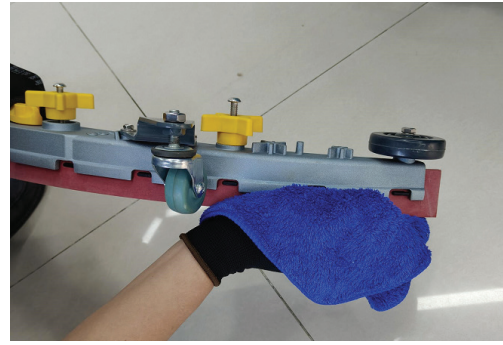

4. Clean brush head skirt and inspect for wear or damage. Replace if worn or damaged.



5. Drain and clean the recovery tank. See “DRAINING THE RECOVERY TANK”.

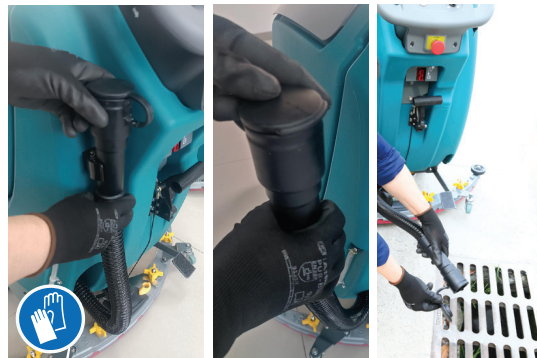

6. Remove and empty debris tray.



- Remove and clean the solution tank filter screen.

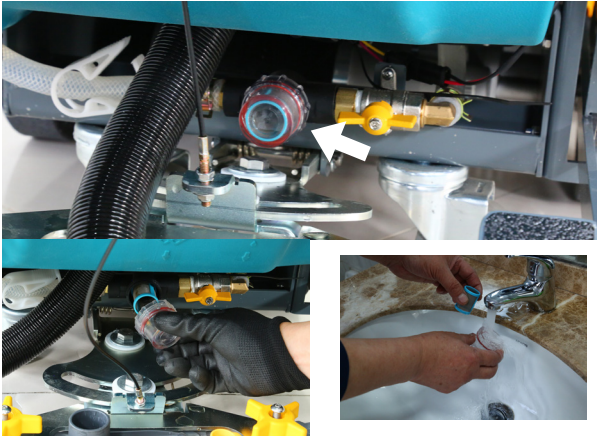

- Drain and rinse the solution tank.

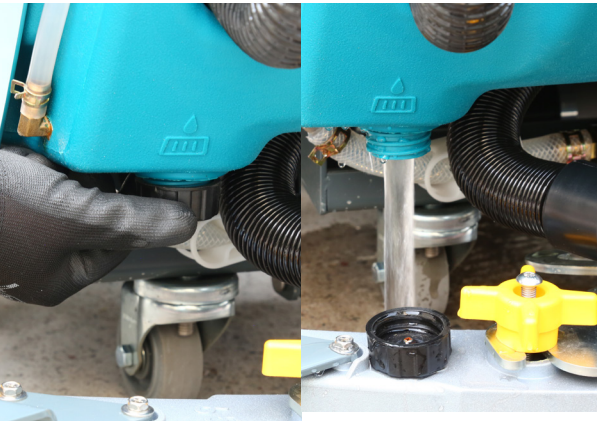

- Charge the batteries. See "Batteries".



- Clean the exterior of the machine with all-purpose cleaner and a damp cloth.



BATTERIES

FOR SAFETY: Before leaving or servicing machine, stop on level surface, turn off machine, and remove key.

Battery life is closely related to proper maintenance. To maximize battery life:

- Do not leave batteries in a partially discharged state for long periods of time.
- Charge in a well ventilated area to prevent gas build-up.
- Fully charge the batteries with the charger before using the machine again.
- Check the fluid level weekly to ensure electrolyte level of the wet batteries is maintained at the proper level.

Your machine is equipped with lead-acid or maintenance-free (sealed AGM) batteries from Tennant.

FOR SAFETY: Keep batteries away from all metal objects while maintaining machine. Avoid contact with battery acid.

MAINTENANCE FREE BATTERIES

The maintenance-free (sealed AGM) batteries do not require watering. However, cleaning and other routine maintenance are still required.

Check connections/cleaning

After every 200 hours of use, check for loose battery connections and clean battery surfaces, including terminals and cord clamps, to avoid battery corrosion. Do not remove the battery cover when cleaning the batteries.

BATTERY CHARGING

The charging instructions in this manual are for the battery charger supplied with the unit. Do not use other battery chargers not supplied and approved by Tennant.

If the machine is equipped with an external battery charger, refer to the charger user manual for operating instructions. If the machine is not equipped with batteries, contact your dealer or Tennant for battery charger recommendations.

FOR SAFETY: Do not use incompatible battery chargers, which may cause battery damage and potential fire.

1. Move the machine to a well-ventilated place.



WARNING: Lead-acid batteries emit hydrogen gas. Explosion or fire can result. Keep sparks and open flame away. Keep covers open when charging.

FOR SAFETY: Before leaving or servicing machine, stop on level surface, turn off machine, and remove key.

2. If the machine is equipped with wet/lead-acid batteries, check the battery electrolyte level weekly before charging.

FOR SAFETY: Do not disconnect the external charger's DC power cord from the machine's outlet while the charger is running. Arc discharge may occur. If charging must be suspended during charging, unplug the AC power cord first.

3. The charger will start charging automatically and will automatically turn off when the batteries are full. The maximum charging period is 6-12 hours, depending on the battery type.



Note: Do not disconnect the battery cords when the charger is plugged into an outlet as this may damage the circuit board.

4. For models equipped with an external charger, always disconnect the AC power cord before disconnecting the charger from the machine.

SQUEEGEE BLADE REPLACEMENT

Each squeegee blade has four wiping edges. If the blade is worn, just flip the blade left or right or up and down, and scrub with the new edge of the blade. Replace with a new blade when all edges are worn.

REPLACE THE SQUEEGEE BLADE ON THE MACHINE

1. Stop the machine and lower the brush head.

FOR SAFETY: Before leaving or servicing machine, stop on level surface, turn off machine, and remove key.

2. Remove the squeegee assembly from the machine.



3. Disconnect the vacuum hose from the squeegee assembly.



4. Remove the squeegee assembly from the machine. Loosen the two outside knobs, this will allow you to remove blades from squeegee frame.

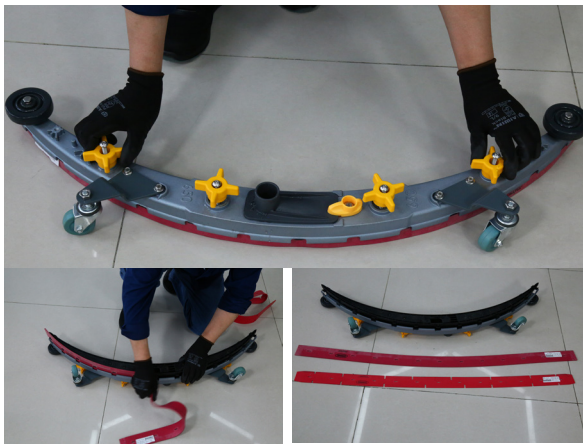

5. Rotate the rear blade to a new wiping edge and reinstall blade. If all four edges are worn, replace with new blade.
6. After replacing the blades, tighten the yellow knobs at both ends.



7. Install the squeegee back onto the squeegee bracket and reconnect the vacuum hose.



PUSHING OR TOWING THE MACHINE

FOR SAFETY: When servicing the machine, do not push or tow the machine without operator control.

If the machine is deactivated, it can be pushed from the front or the rear, but can only be towed from the front.

Do not push or tow the machine at long distances or high speeds.

Note: DO NOT push or tow the machine over long distances as this can cause damage to the driving system.

TRANSPORTING THE MACHINE

When using a trailer or truck to transport the machine, carefully observe the following loading and tie-down procedures:

1. Drain the tanks, lift up the brush head, and remove the squeegee assembly.
2. Carefully load the machine onto a trailer or truck.

FOR SAFETY: When loading/unloading, use a ramp that support the weight of the machine and the driver to load the machine. Do not turn on slopes or ramps. Do not drive on slippery ramps.

FOR SAFETY: When loading/unloading, do not operate the machine on ramp incline exceeds 2%. A winch must be used when the ramp incline exceeds 2%.

3. Once loaded, position the front of the machine against the front of the trailer or truck. Lower the brush head and turn off the key.
4. Place a stop behind each wheel.
5. Use tie-wraps to secure the machine to the four tie-down brackets on the machine frame. It may be necessary to mount the tie-down brackets to the floor of the trailer or truck.

NOTE: When transporting the machine with an open truck or trailer, make sure the recovery tank cover is closed tightly.

NOTE: The console area or replacement part storage track is not intended to be tied down as damage may result.

STORAGE OF THE MACHINE

To store the machine for long periods, follow steps below.

1. Charge the batteries before storing machine to extend battery life. Recharge the batteries once a month.
2. Disconnect the batteries before storing.
3. 3. Drain and clean the recovery and water tanks.
4. Store the machine in a dry area with the squeegee and brush head in the up position.

NOTE: Do not expose the machine to rain, it should be stored indoors.

5. Open the recovery tank cover to allow air to circulate.
6. If the machine is stored at freezing temperatures, see “Antifreeze Protection” .

Note: To prevent possible damage to the machine, store the machine in an environment free of rodents and insects.

ANTIFREEZE PROTECTION

Storing machine in freezing temperatures.

1. Drain all water from the solution tank and recovery tank.
2. Empty the water from the solution tank filter located under the machine. Replace the filter.

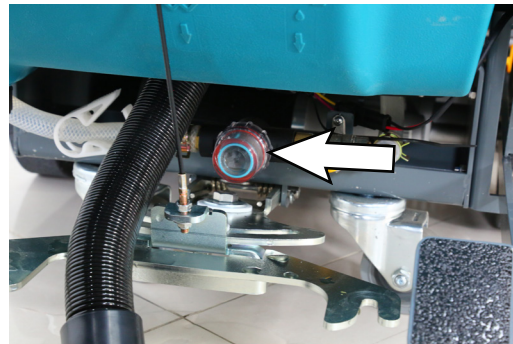

TROUBLESHOOTING

PROBLEM	CAUSE	SOLUTION
Machine will not operate	Emergency shutoff button is activated	Turn button to reset
	Machine fault detected	Contact service
	Batteries dead	Charge batteries
	Battery cables loose	Tighten loose cables
	Battery fault	Replace battery
	Key switch fault	Contact service
	Yellow handle button fault	Contact service
	Circuit breaker tripped	Reset circuit breaker
	Control board fault	Contact service
Battery charger not working	Plug not connected to power source	Check plug connection
	Battery over discharged	Replace battery
	Battery charger fault detected	Contact service
	Charger fault	Replace charger
	Power cord fault	Replace power cord
Machine will not propel	Propel fault detected	Contact service
	Propel motor or wiring fault	Contact service
	Motor carbon brushes worn	Contact service
Scrub brush motor not working	Brush motor fault detected	Contact service
	Brush motor or wiring fault	Contact service
	Motor carbon brushes worn	Contact service
	Circuit breaker tripped	Reset circuit breaker
Vacuum motor not working	Squeegee assembly lifted off floor	Lower squeegee assembly to floor
	Vacuum motor fault detected	Contact service
	Faulty vacuum motor or wiring	Contact service
	Circuit breaker tripped	Reset circuit breaker
Poor scrubbing performance	Debris in scrub/brush pad	Remove debris
	Worn scrub/brush pad	Replace scrub brush/pad
	Wrong scrub brush pressure	Adjust scrub brush pressure
	Wrong scrub/brush pad type	Use correct scrub brush/pad type
	Battery charge low	Charge battery
	Uneven scrub brush pressure	Scrub head/scrub brush not level. Contact service

TROUBLESHOOTING -

PROBLEM	CAUSE	SOLUTION
Water trailing	Recovery tank full or excessive foaming	Drain recovery tank
	Loosen drain cap	Replace cap
	Worn squeegee blades	Rotate or replace squeegee blades
	Condensate trap clogged (squeegee assembly)	Remove cap and clean
	Squeegee assembly clogged	Clean squeegee assembly
	Loose vacuum hose connector	Tighten vacuum hose connector
	Clogged vacuum hose	Flush vacuum hose
	Damaged vacuum hose	Replace vacuum hose
	Clogged float cage screen in recovery tank	Clean screen
	Recovery tank cap not fully closed	Check cap for clogs
	Defective seal on recovery tank cap	Replace seal
Little or no solution flow	Empty solution tank	Refill solution tank
	Solution flow rate set low	Increase solution flow rate
	Solution tank filter clogged	Clean filter
	Solution supply line clogged	Flush solution supply line
Shortened operating time	Low battery	Charge the battery
	Battery requires maintenance	See "Battery"
	Battery fault or has reached the end of its service life	Replace battery
	Charger fault	Replace the battery charger
	Brush pressure set too high	Reduce brush pressure

SPECIFICATIONS

GENERAL MACHINE

Model	T360
Length	1335mm / 52.5 in
Width (machine body)	750mm / 29.5 in
Height	1130mm / 44.4 in
Machine weight	106.4 KG / 234 lb
Machine weight (with battery)	182.4 KG / 402 lb
Squeegee width	973 mm / 38.3 in
Solution tank capacity	70L / 18.5 gal
Recovery tank capacity	75L / 19.8 gal
Scrubbing width	700 mm / 27.5 in
Down pressure	30 kg / 66.1 lbs
Scrubbing speed	Maximum 1.22m/s minimum 0.02m/s
Transport speed	1.23 m/s
Reverse speed	0.68 m/s
Productivity - actual estimate	2940 m ² /hr
Turning diameter	1120 mm / 44 in
Scrubbing incline	2%
Solution flow rate	25%: 1.46L/min 0.57 liters, 50%:3.30L/min, 100%: 3.66L/min
Scrub brush motor	2x24VDC 360w
Propel motor	24VDC 400w
Vacuum motor	24VDC 450w
Machine voltage	24V DC
Battery capacity	120 Ah @ 3 hr
smart external battery charger	110-240Vac, 50/60 Hz, 24 Vdc, 15A
SProtection level	IPX3
Sound pressure level LpA*	65.1 dBA
Machine-to-arm vibration	<2.5 m/s ²
Ambient operating temperature	Min:36° F / 2° C Max:110° F / 43° C

* Values based on IEC 60335-2-72. Specifications are subject to change without notice.

MACHINE DIMENSIONS

